

CATALOGO OFICIAL

MDT



PDP



PERFILES DEL PILAR

MDT





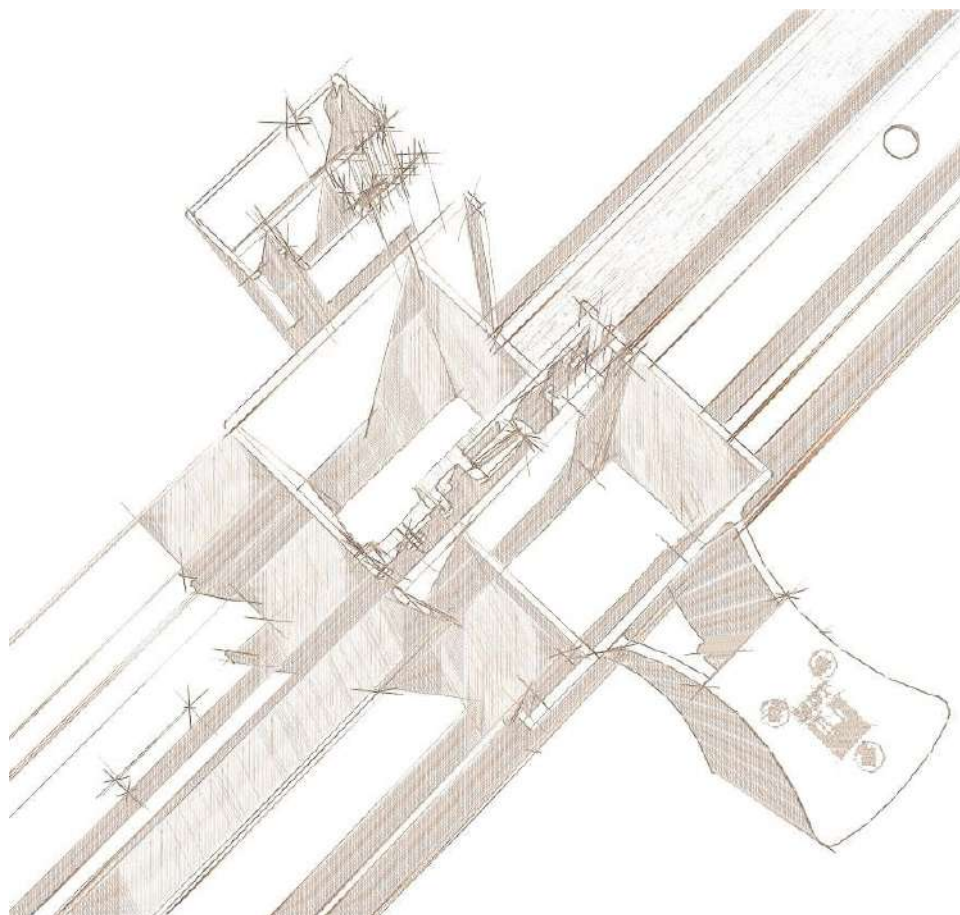





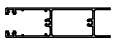















**TECNOLOGÍA EN
ALUMINIO Y VIDRIO**

































MASS **R**60













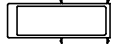







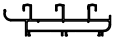

Listado de Perfiles

CÓDIGO	PESO (kg/m)	DESCRIPCIÓN	FORMA	PÁG
MT-6501	0.848	Cabezal - Zócalo corte a 90°		01
MT-6502	1.396	Zócalo alto corte a 90°		01
MT-6503	1.226	Parante lateral de hoja corte a 90°		01
MT-6504	1.204	Parante central de hoja corte a 90°		01
MT-6505	0.316	Tope mosquitero corte a 90°		01
MT-6506	3.175	Parante super reforzado corte a 90°		02
MT-6507	1.631	Parante central reforzado corte a 90°		02
MT-6508	0.286	Adaptador VS corte a 90°		02
MT-6510	1.274	Jambas de tres guías corte a 90°		01
MT-6511	0.797	Jambas de marco corte a 90°		03
MT-6512	1.630	Umbral - Dintel de marco corte a 90°		03
MT-6513	0.085	Guía de marco corte a 90°		03
MT-6514	0.286	Encuentro central para cuatro hojas corte a 90°		03
MT-6515	2.314	Umbral y dintel de marco de tres guías corte a 90°		03
MT-6516	0.867	Premarco para corredera de 3 guías corte a 90°		04
MT-6517	0.532	Premarco		04
MT-6520	0.948	Marco para paño fijo		08
MT-6521	1.094	Travesaño para paño fijo		08
MT-6522	0.970	Marco para ventana de abrir		08
MT-6523	1.240	Marco para puerta de rebatir		08
MT-6524	0.835	Marco para ventana desplazable		08
MT-6525	1.045	Marco ventana escalonada		08
MT-6526	1.037	Hoja para ventana de abrir		09
MT-6528	1.380	Hoja para puerta de rebatir		09
MT-6529	1.508	Travesaño para puerta de rebatir		09
MT-6530	2.395	Zócalo para puerta de rebatir		12

Listado de Perfiles

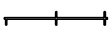
CÓDIGO	PESO (kg/m)	DESCRIPCIÓN	FORMA	PÁG
MT-6531	1.026	Encuentro central para ventana de abrir		10
MT-6532	1.373	Hoja para ventana desplazable		10
MT-6533	0.204	Contra vidrio recto exterior de puerta		13
MT-6534	0.368	Contra vidrio recto interior 40mm		13
MT-6535	0.166	Contra vidrio recto interior 15mm corte 45°		15
MT-6536	0.481	Acople a 180° módulo 60mm a 3 guías corte a 90°		09
MT-6537	1.472	Marco de dos guías 45° Recto		06
MT-6538	2.157	Marco de tres guías 45° Recto		06
MT-6559	1.280	Hoja corrediza DVH (luz 36 mm)		07
MT-6567	1.291	Travesaño Batiente + PF		06

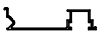
CÓDIGO	PESO (kg/m)	DESCRIPCIÓN	FORMA	PÁG
MT-0206	0.184	Tapa junta		04
MT-0212	0.315	Contravidrio recto interior 36mm		13
MT-0217	0.292	Contravidrio recto interior 29mm		13
MT-0225	0.257	Contravidrio recto interior 22mm		13
MT-0226	0.210	Contravidrio recto interior 15mm		13
MT-0230	0.213	Contravidrio curvo interior 29mm		17
MT-0231	0.159	Contravidrio curvo interior 15mm		17
MT-0232	0.181	Contravidrio curvo interior 22mm		17
MT-0233	0.135	Contravidrio curvo interior 8mm		17
MT-0238	0.183	Contravidrio recto interior 8mm		17
MT-0245	0.623	Tapa cinta		04
MT-0255	0.389	Hoja para mosquitero		02
MT-0256	0.446	Travesaño para mosquitero		02
MT-0257	0.235	Contravidrio curvo interior 36mm		17
MT-0326	0.617	Hoja para mosquitero reforzado		02
MT-0351	0.300	Acople 180°, módulo 60 a 45mm		10
MT-0379	1.102	Refuerzo parante central corte a 45°		06
MT-0390	0.915	Premarco para corrediza de 3 guías corte a 45°		06
MT-0394	0.817	Caja de agua auxiliar		03
MT-0397	1.370	Hoja ventana corrediza DVH (luz 30 mm)		08

CÓDIGO	PESO (kg/m)	DESCRIPCIÓN	FORMA	PÁG
MT-0401	0.343	Acople a 180°, módulo de 60mm		12
MT-0402	0.429	Solapa central 45° para MT-0397		08
MT-0412	3.494	Acople reforzado a 180° módulo de 60mm - Columna		12
MT-0415	0.200	Tapa junta recto		04
MT-0534	1.053	Refuerzo parante central corte a 90°		11
MT-0615	0.246	Adaptador VS 45° Recta		08
MT-0619	1.118	Hoja ventana corrediza DVH (luz 30 mm)		09
MT-0621	0.405	Solapa central 45° para MT-0619		09
MT-3202	0.348	Tapa junta curvo		11
MT-4001	1.380	Hoja corrediza DVH 22mm corte a 45°		06
MT-4007	0.473	Encuentro central para 4 hojas corte a 45°		07
MT-4010	1.488	Hoja corrediza VS luz 12mm corte a 45°		06
MT-4011	1.350	Hoja corrediza DVH luz 30mm corte a 45°		06
MT-4020	0.964	Encuentro central para puerta de rebatir		14
MT-4021	2.265	Marco de tres guías corte a 45°		07
MT-4022	1.444	Marco de dos guías corte a 45°		06
MT-4023	0.371	Solapa central corte a 45°		12
MT-4024	0.946	Acople a 90°, módulo de 60mm		19
MT-4025	0.722	Acople a 135°, módulo de 60mm		19
MT-4026	0.681	Acople a 180°, módulo de 60mm a 3 guías corte 45°		17
MT-4028	0.340	Bisagra tapa cinta		11
MT-4029	0.713	Guía para cortina		11
MT-6090	0.159	Pletina		13
MT-6151	0.732	Hoja para mosquitero súper reforzado corte a 45°		13

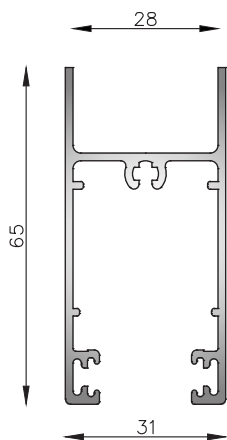

MT-6501
Cabezal y zócalo corrediza 90°
Peso estimado: 0.848 Kg/m
Largo STD: 6200 mm

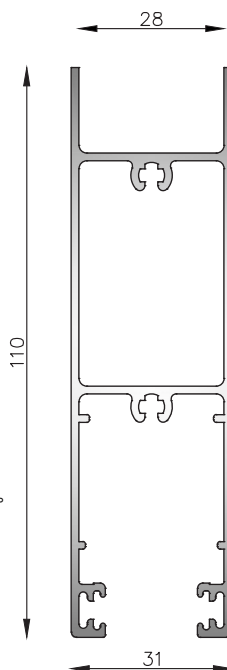

MT-6502
Zócalo alto corrediza 90°
Peso estimado: 1.396 Kg/m
Largo STD: 6200 mm

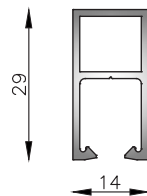

MT-6505
Tope mosquitero 90°
Peso estimado: 0.316 Kg/m
Largo STD: 6200 mm

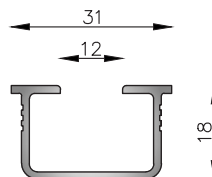

MT-6508
Adaptador VS 90°
Peso estimado: 0.286 Kg/m
Largo STD: 6200 mm

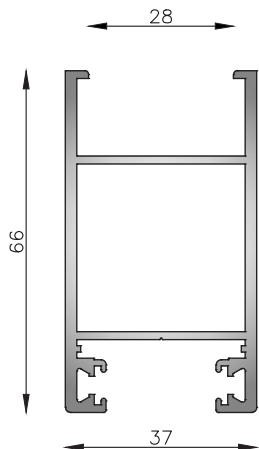

MT-6503
Parante lateral de hoja 90°
Peso estimado: 1.226 Kg/m
Largo STD: 6200 mm

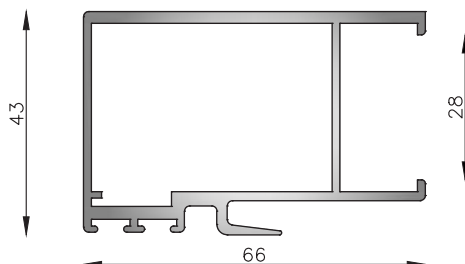

MT-6504
Parante central de hoja 90°
Peso estimado: 1.204 Kg/m
Largo STD: 6200 mm

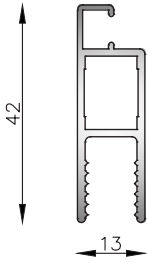

MT-0255

Hoja para mosquitero
Peso estimado: 0.389 Kg/m
Largo STD: 6030 mm

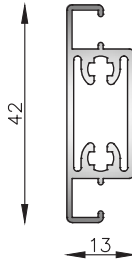

MT-0256

Travesaño para mosquitero
Peso estimado: 0.446 Kg/m
Largo STD: 6030 mm

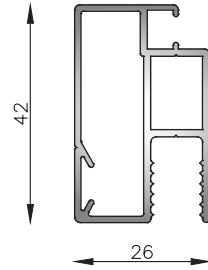

MT-0326

Hoja para mosquitero reforzado
Peso estimado: 0.617 Kg/m
Largo STD: 6200 mm

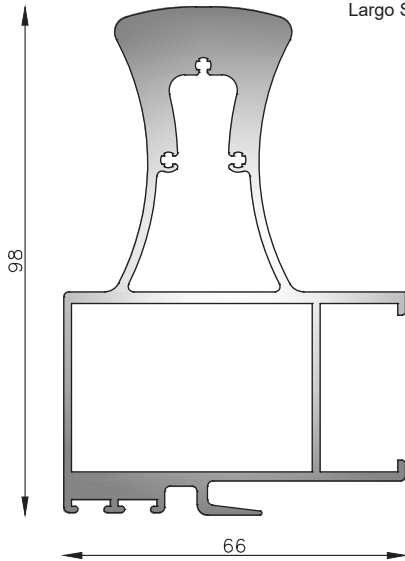

MT-6506

Parante súper reforzado 90°
Peso estimado: 3.175 Kg/m
Largo STD: 6200 mm

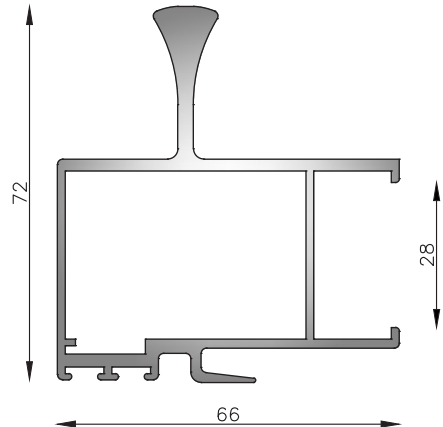

MT-6507

Parante central reforzado 90°
Peso estimado: 1.631 Kg/m
Largo STD: 6200 mm

MT-6510

Jambas de 3 guías 90°
Peso estimado: 1.274 Kg/m
Largo STD: 6200 mm

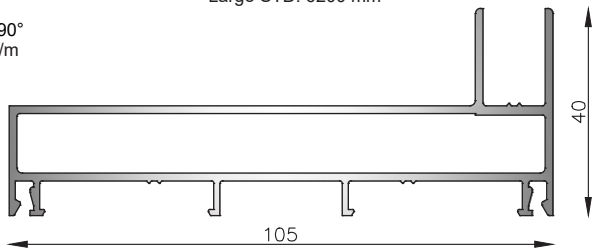

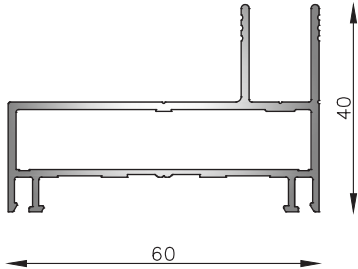

MT-6511
 Jamba de marco 90°
 Peso estimado: 0.797 Kg/m
 Largo STD: 6200 mm

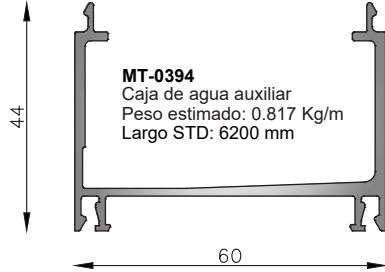

MT-0394
 Caja de agua auxiliar
 Peso estimado: 0.817 Kg/m
 Largo STD: 6200 mm

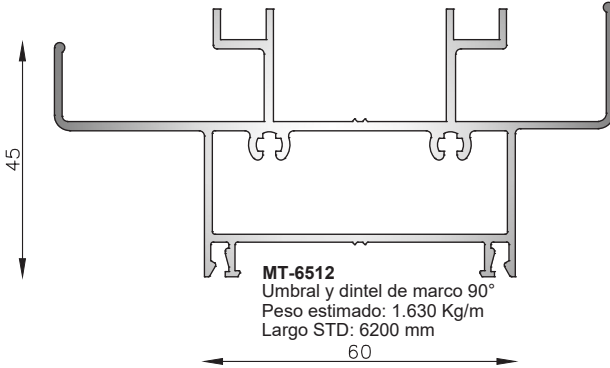

MT-6512
 Umbral y dintel de marco 90°
 Peso estimado: 1.630 Kg/m
 Largo STD: 6200 mm

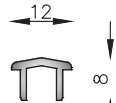

MT-6513
 Guía de marco 90°
 Peso estimado: 0.085 Kg/m
 Largo STD: 6200 mm

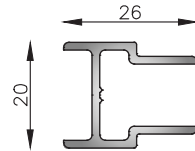

MT-6514
 Encuentro central para 4 hojas 90°
 Peso estimado: 0.286 Kg/m
 Largo STD: 6200 mm

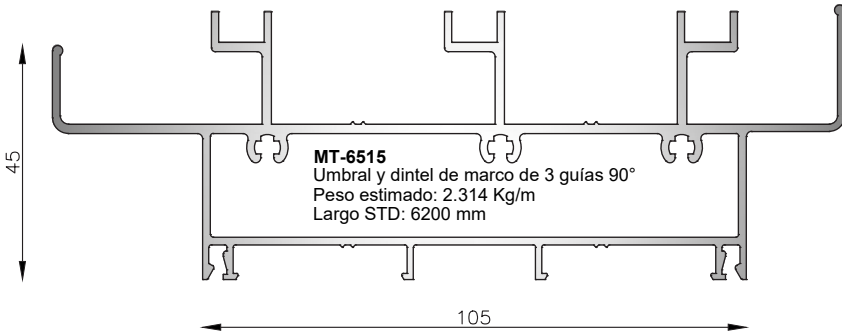

MT-6515
 Umbral y dintel de marco de 3 guías 90°
 Peso estimado: 2.314 Kg/m
 Largo STD: 6200 mm

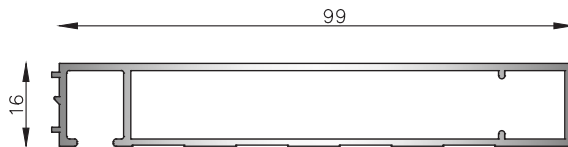

MT-6516
 Premarco para corrediza de 3 guías 90°
 Peso estimado: 0.867 Kg/m
 Largo STD: 6200 mm

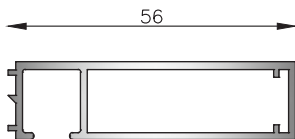

MT-6517
 Premarco
 Peso estimado: 0.532 Kg/m
 Largo STD: 6200 mm

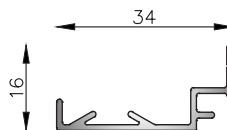

MT-0415
 Tapa junta recto
 Peso estimado: 0.200 Kg/m
 Largo STD: 6150 mm

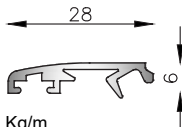

MT-0206
 Tapa junta
 Peso estimado: 0.184 Kg/m
 Largo STD: 6150 mm

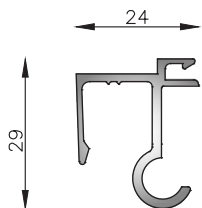

MT-4028
 Bisagra tapa cinta
 Peso estimado: 0.340 Kg/m
 Largo STD: 6200 mm

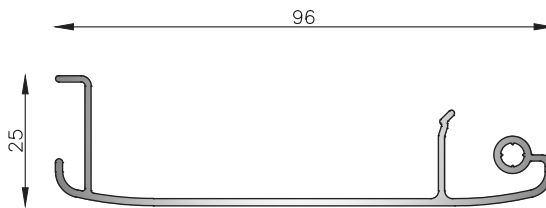

MT-0245
 Tapa cinta
 Peso estimado: 0.623 Kg/m
 Largo STD: 6150 mm

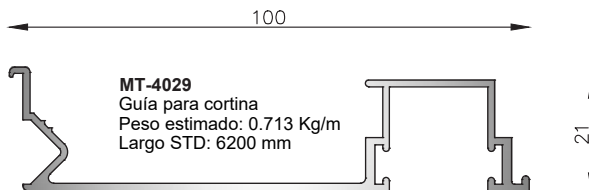

MT-4029
 Guía para cortina
 Peso estimado: 0.713 Kg/m
 Largo STD: 6200 mm

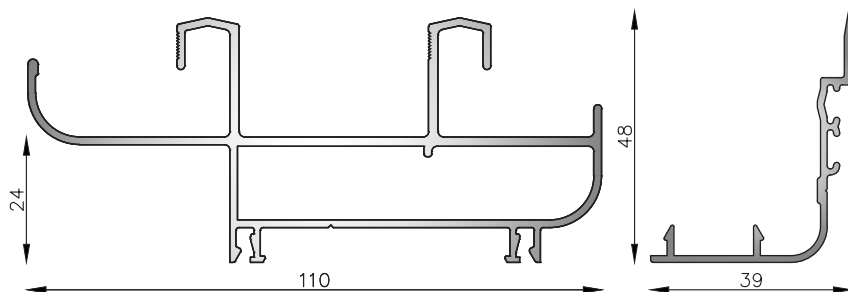

MT-4022
 Marco de dos guías 45°
 Peso estimado: 1.444 Kg/m
 Largo STD: 6200 mm

MT-4023
 Solapa central 45°
 Peso estimado: 0.371 Kg/m
 Largo STD: 6200 mm

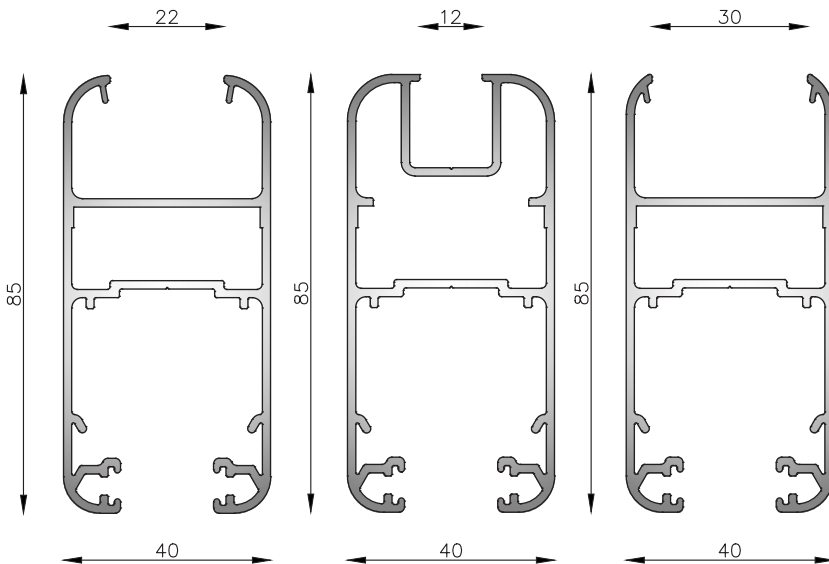

MT-4001
 Hoja corrediza DVH (luz 22 mm)
 Peso estimado: 1.380 Kg/m
 Largo STD: 6200 mm

MT-4010
 Hoja corrediza VS (luz 12 mm)
 Peso estimado: 1.488 Kg/m
 Largo STD: 6200 mm

MT-4011
 Hoja corrediza DVH (luz 30 mm)
 Peso estimado: 1.350 Kg/m
 Largo STD: 6200 mm

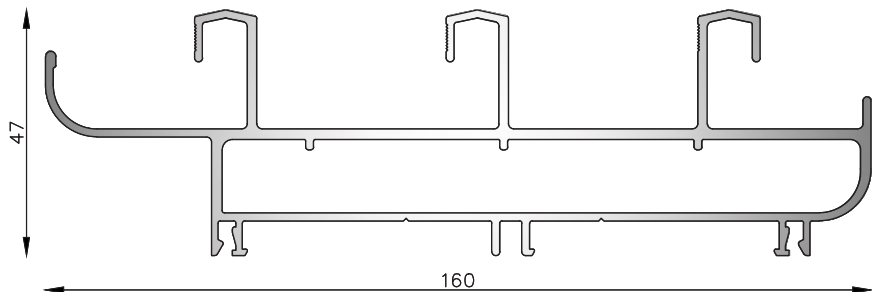

MT-4021
 Marco de tres guías 45°
 Peso estimado: 2.265 Kg/m
 Largo STD: 6200 mm

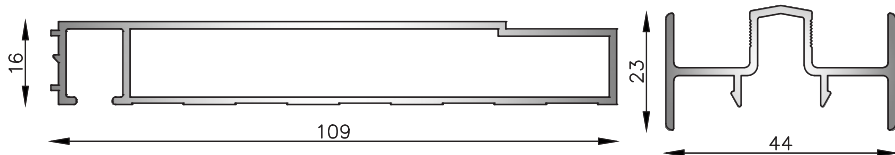

MT-0390
 Premarco corrediza 3 guías 45°
 Peso estimado: 0.915 Kg/m
 Largo STD: 6200 mm

MT-4007
 Encuentro central para 4 hojas
 Peso estimado: 0.473 Kg/m
 Largo STD: 6200 mm

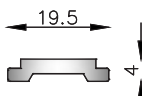

MT-6090
 Pletina
 Peso estimado: 0.159 Kg/m
 Largo STD: 6030 mm

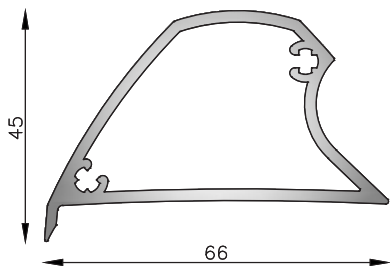

MT-0379
 Refuerzo de parante central 45°
 Peso estimado: 1.102 Kg/m
 Largo STD: 6200 mm

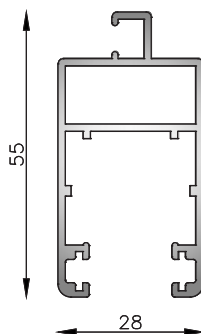

MT-6151
 Hoja para mosquitero súper reforzado 45°
 Peso estimado: 0.732 Kg/m
 Largo STD: 6200 mm

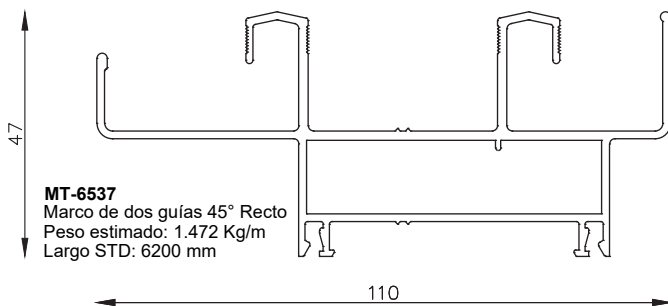

MT-6538
 Marco de tres guías 45° Recto
 Peso estimado: 2.157 Kg/m
 Largo STD: 6200 mm

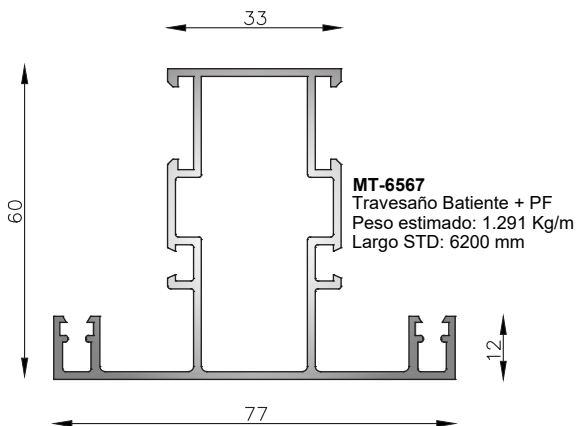
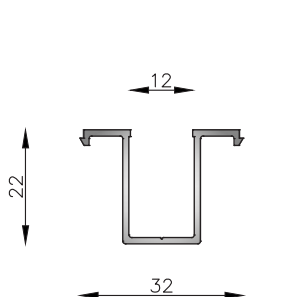
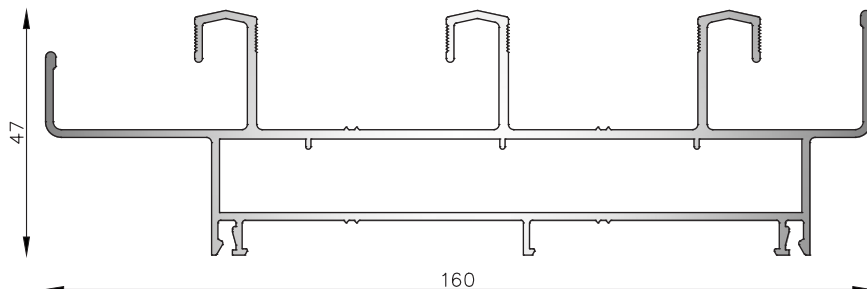

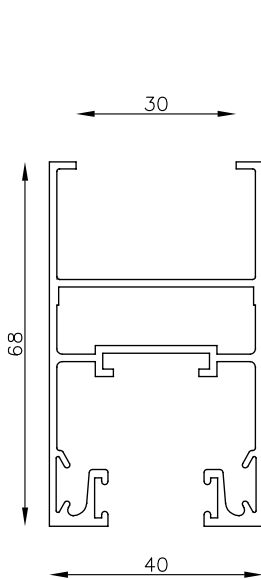

MT-0619

Hoja ventana corrediza DVH (luz 30 mm)
 Peso estimado: 1.118 Kg/m
 Largo STD: 6200 mm

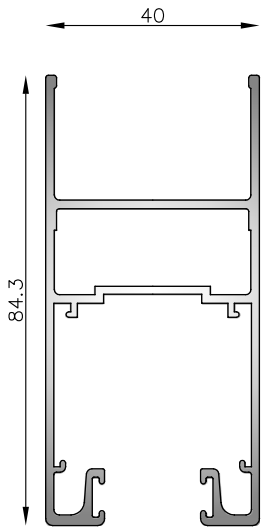

MT-6559

Hoja corrediza DVH (luz 36 mm)
 Peso estimado: 1.280 Kg/m
 Largo STD: 6200 mm

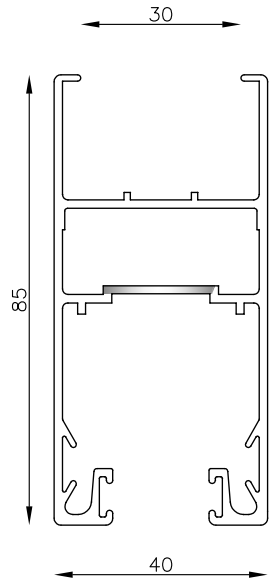

MT-0397

Hoja corrediza DVH (luz 30 mm)
 Peso estimado: 1.370 Kg/m
 Largo STD: 6200 mm

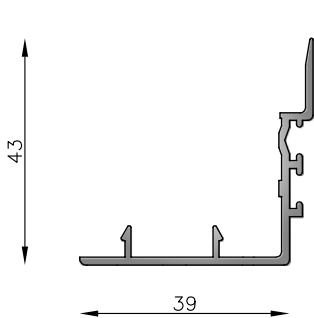

MT-0621

Solapa central 45° para MT-0619
 Peso estimado: 0.405 Kg/m
 Largo STD: 6200 mm

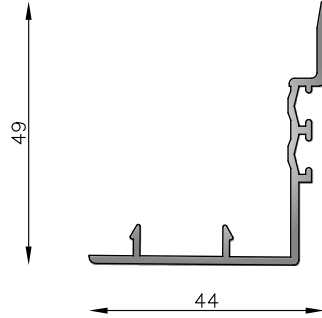

MT-0402

Solapa central 45° para MT-0397
 Peso estimado: 0.429 Kg/m
 Largo STD: 6200 mm

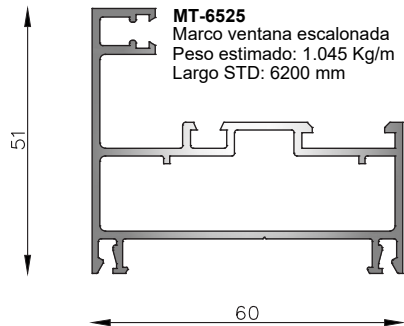
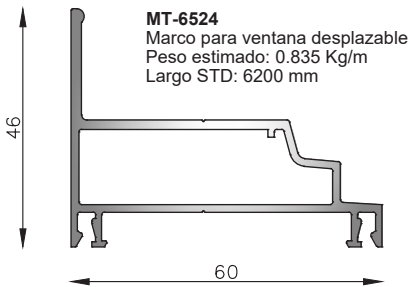
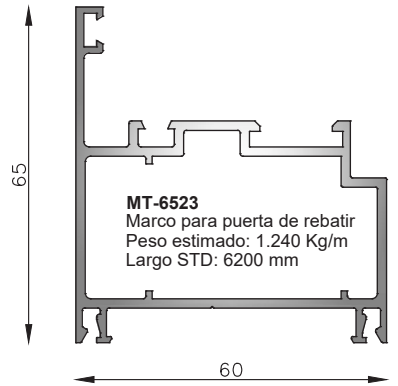
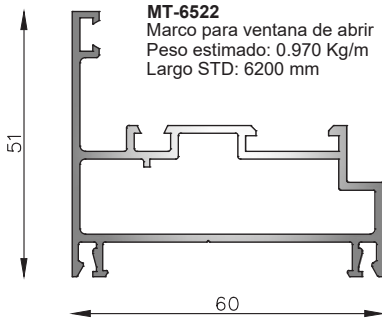
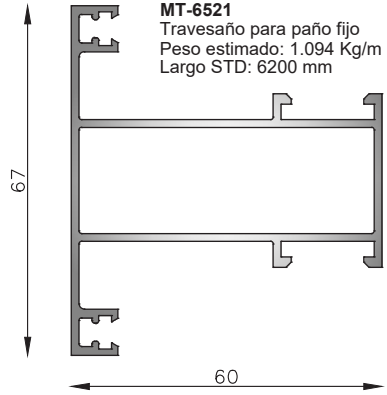
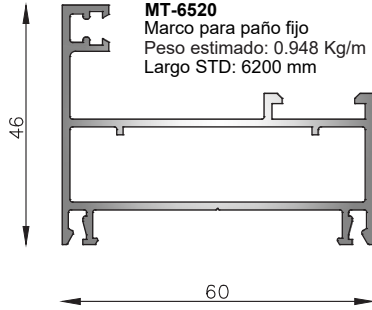

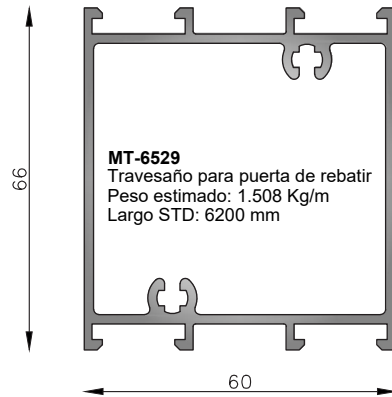
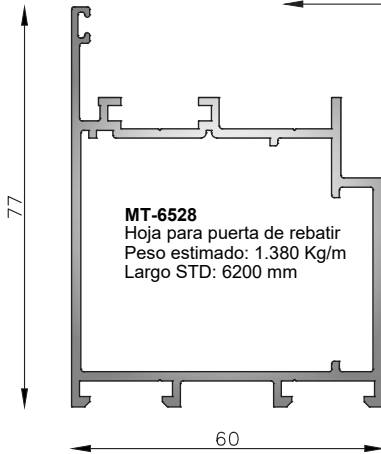
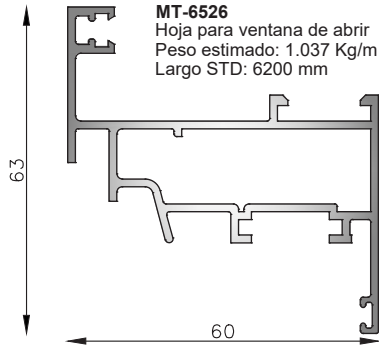

MT-6536
 Acople a 180° de 3 guías 90°
 Peso estimado: 0.481 Kg/m
 Largo STD: 6200 mm

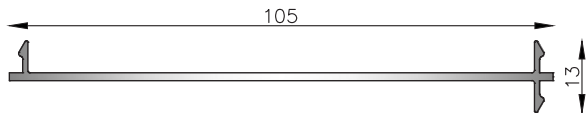

MT-4026
 Acople a 180° módulo de 60mm a 3 guías corte a 45°
 Peso estimado: 0.681 Kg/m
 Largo STD: 6200 mm

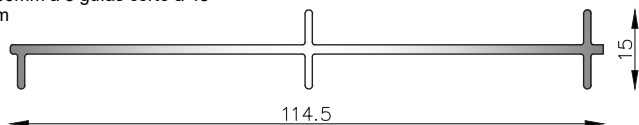

MT-6531

Encuentro central para ventana
 Peso estimado: 1.026 Kg/m
 Largo STD: 6200 mm

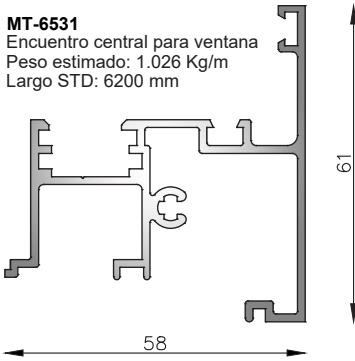

60

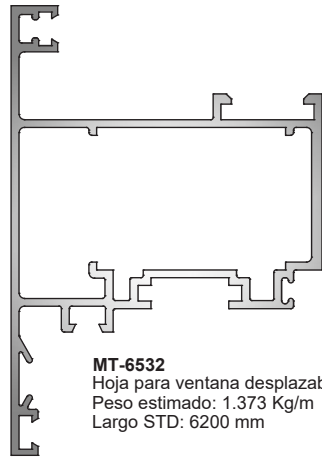

MT-6532

Hoja para ventana desplazable
 Peso estimado: 1.373 Kg/m
 Largo STD: 6200 mm

87

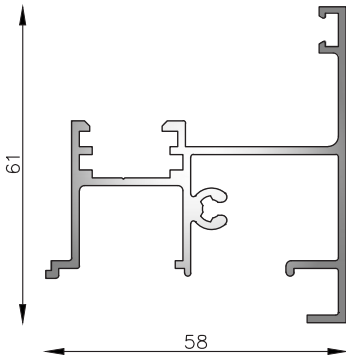

61

58

48

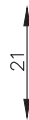

21

MT-3202

Tapa junta curvo
 Peso estimado: 0.348 Kg/m
 Largo STD: 6200 mm

MT-4020

Encuentro central para puerta de rebatir
 Peso estimado: 0.964 Kg/m
 Largo STD: 6200 mm

66

MT-0534

Refuerzo parante central 90°
 Peso estimado: 1.053 Kg/m
 Largo STD: 6200 mm

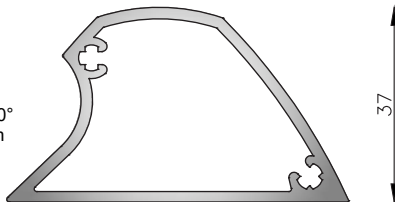

37

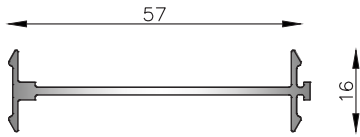

MT-0401
 Acople a 180°, módulo de 60mm
 Peso estimado: 0.343 Kg/m
 Largo STD: 6200 mm

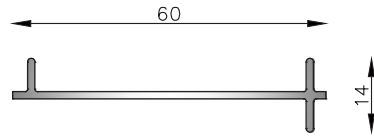

MT-0351
 Acople a 180°, módulo de 60mm a 45mm
 Peso estimado: 0.300 Kg/m
 Largo STD: 6200 mm

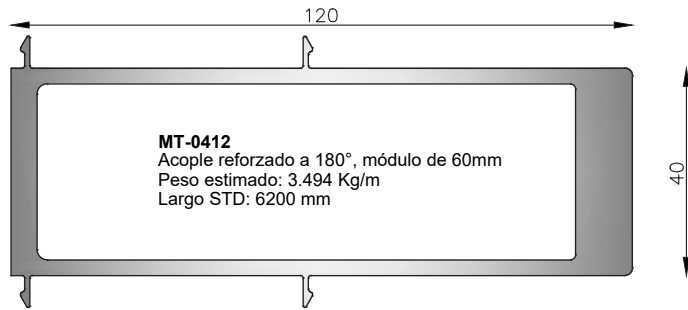

MT-0412
 Acople reforzado a 180°, módulo de 60mm
 Peso estimado: 3.494 Kg/m
 Largo STD: 6200 mm

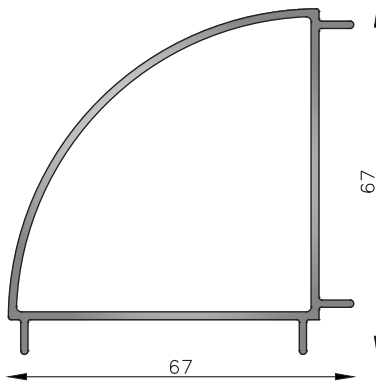

MT-4024
 Acople a 90°, módulo 60mm
 Peso estimado: 0.946 Kg/m
 Largo STD: 6200 mm

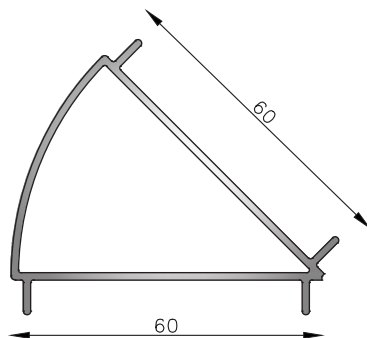

MT-4025
 Acople a 135°, módulo 60mm
 Peso estimado: 0.722 Kg/m
 Largo STD: 6200 mm

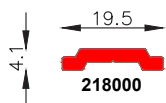
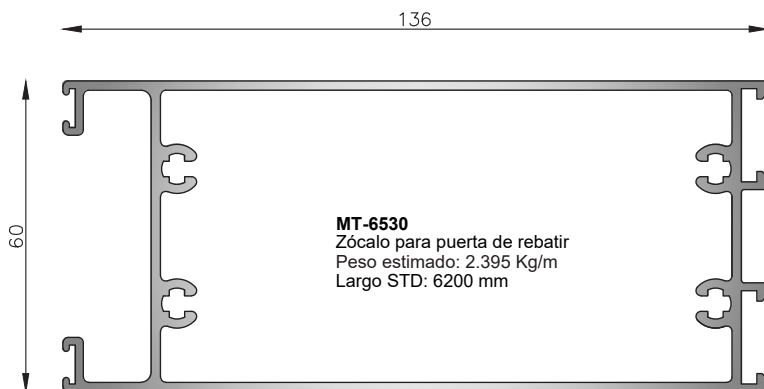

Pletina para falleba en varilla de poliamida (Estándar)
Código 218000

Se aplica en hojas batientes con cámara europea
 Largo de tira 6200 mm

(No apta para herrajes Roto Frank)

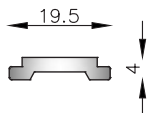

MT-6090

Pletina estándar en aluminio
 Peso estimado: 0.159 Kg/m
 Largo STD: 6030 mm
 (No apta para herrajes Roto Frank)
 (Ver opción en PA superior)

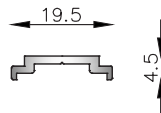

MT-6518

Pletina Roto Frank en aluminio
 Peso estimado: 0.103 Kg/m
 Largo STD: 6030 mm
 (Apta para todos los herrajes Estándar)

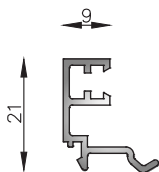

MT-6533
 Contravidrio recto exterior de puerta
 Peso estimado: 0.204 Kg/m
 Largo STD: 6030 mm

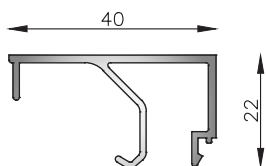
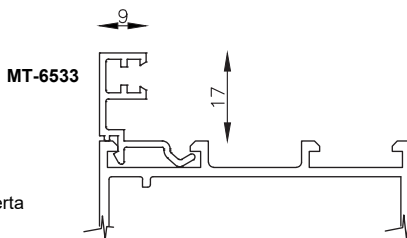

MT-6534
 Contravidrio recto interior 40mm
 Peso estimado: 0.368 Kg/m
 Largo STD: 6030 mm

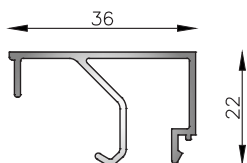
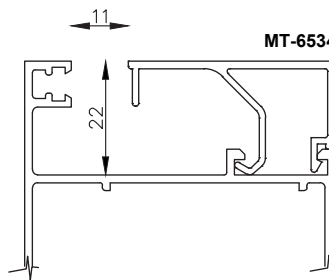

MT-0212
 Contravidrio recto interior 36mm
 Peso estimado: 0.315 Kg/m
 Largo STD: 6030 mm

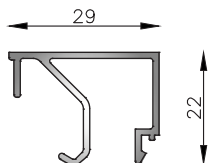
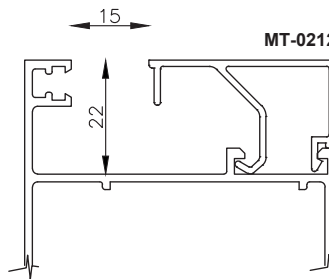

MT-0217
 Contravidrio recto interior 29mm
 Peso estimado: 0.292 Kg/m
 Largo STD: 6030 mm

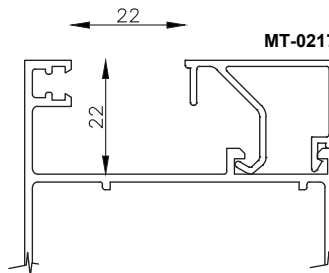

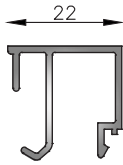

MT-0225
 Contravidrio recto interior 22mm
 Peso estimado: 0.257 Kg/m
 Largo STD: 6030 mm



MT-0226
 Contravidrio recto interior 15mm
 Peso estimado: 0.210 Kg/m
 Largo STD: 6030 mm

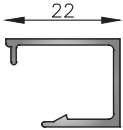

MT-6569
 Mass R60 Contravidrio 17 mm
 Peso estimado: 0.194 Kg/m
 Largo STD: 6200 mm

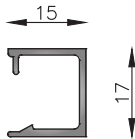

MT-6535
 Contravidrio recto interior 15mm a 45°
 Peso estimado: 0.166 Kg/m
 Largo STD: 6030 mm

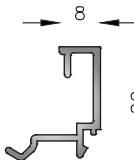

MT-0238
 Contravidrio recto interior 8mm
 Peso estimado: 0.183 Kg/m
 Largo STD: 6030 mm

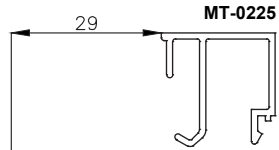

MT-0225

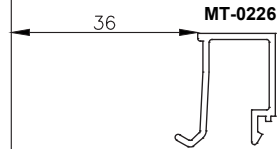

MT-0226

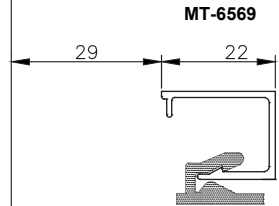

MT-6569

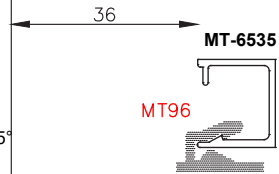

MT-6535

MT96

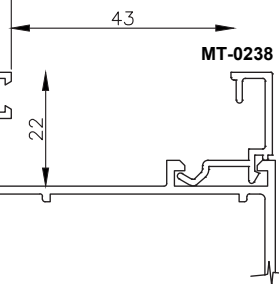

MT-0238



Atención: Colocar un clip de contravidrio MT96 a 40mm de cada esquina y el resto a una distancia máxima de 200mm entre cada uno. En caso de necesitar retirar el contravidrio cambiar los MT96, debido a que pierde su capacidad de

Contravidrios para Paño Fijo

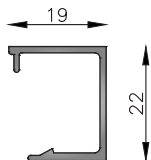

MT-6568
 Contravidrio recto interior 19 mm
 "Batiente + PF"
 Peso estimado: 0.194 Kg/m
 Largo STD: 6200 mm

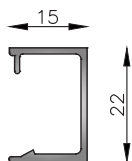

MT-6332
 Contravidrio recto interior 15 mm
 "Batiente + PF"
 Peso estimado: 0.181 Kg/m
 Largo STD: 6200 mm

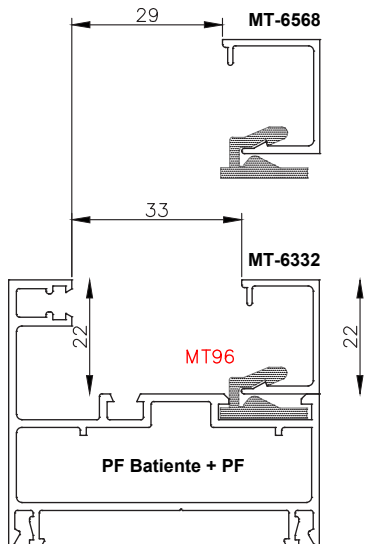

Contravidrios para Batientes

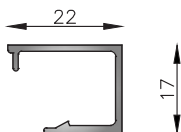

MT-6569
 Contravidrio recto interior 22 mm
 Peso estimado: 0.189 Kg/m
 Largo STD: 6200 mm

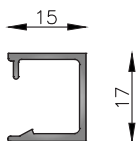

MT-6535
 Contravidrio recto interior de 15mm
 Peso estimado: 0.166 Kg/m
 Largo STD: 6030 mm

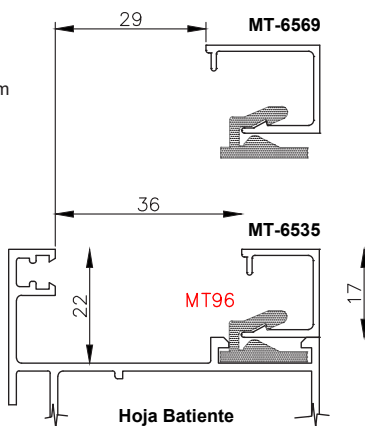

Atención: Colocar un clip de contravidrio MT96 a 40mm de cada esquina y el resto a una distancia máxima de 200mm entre cada uno. En caso de necesitar retirar el contravidrio cambiar los MT96, debido a que pierde su capacidad de

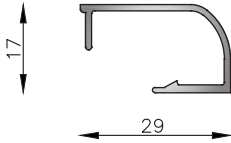

MT-0230
 Contravidrio curvo interior 29mm
 Peso estimado: 0.213 Kg/m
 Largo STD: 6030 mm

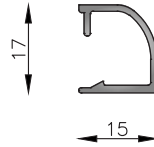

MT-0231
 Contravidrio curvo interior 15mm
 Peso estimado: 0.159 Kg/m
 Largo STD: 6030 mm

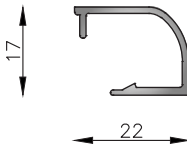

MT-0232
 Contravidrio curvo interior 22mm
 Peso estimado: 0.181 Kg/m
 Largo STD: 6030 mm

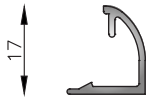
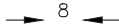

MT-0233
 Contravidrio curvo interior 8mm
 Peso estimado: 0.135 Kg/m
 Largo STD: 6030 mm

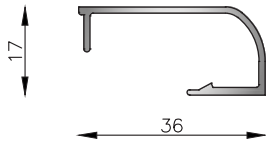

MT-0257
 Contravidrio curvo interior 36mm
 Peso estimado: 0.235 Kg/m
 Largo STD: 6030 mm

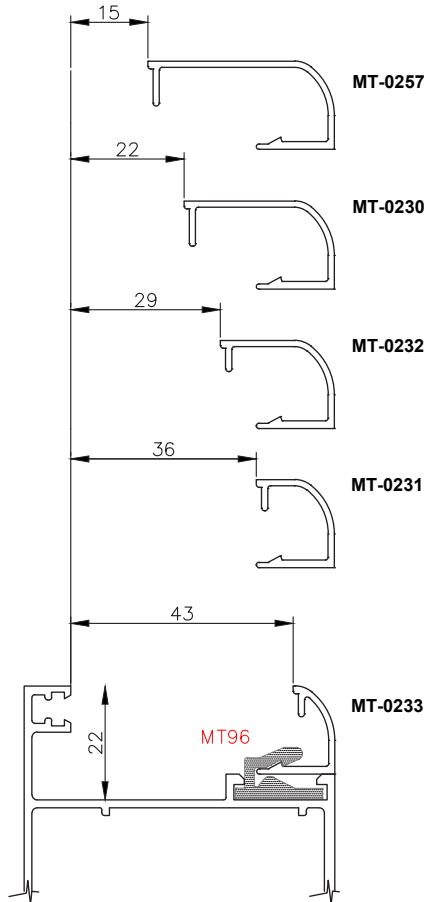

Atención: Colocar un clip de contravidrio MT96 a 40mm de cada esquina y el resto a una distancia máxima de 200mm entre cada uno. En caso de necesitar retirar el contravidrio cambiar los MT96, debido a que pierde su capacidad de