

# CATALOGO OFICIAL

**MDT**



















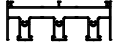

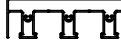
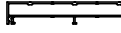
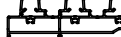
**PDP**



PERFILES DEL PILAR

## MASS R60 Alzante



CÓDIGO	PESO (kg/m)	DESCRIPCIÓN	FORMA	Pág
MT-6548	0.963	Hoja perimetral DVH		01
MT-6549	1.028	Hoja perimetral VS		01
MT-6544	0.165	Marco Lateral		01
MT-6545	0.097	Tapa parante lateral		01
MT-6541	0.235	Guía postiza		01
MT-6550	0.204	Tapa de hoja		01
MT-6546	0.204	Solapa de hoja		01
MT-6508	1.649	Marco Dintel		02
MT-6542	0.864	Marco Lateral		02
MT-6539	1.396	Marco Umbral		02
MT-6547	2.305	Marco Dintel 3 guías		03
MT-6543	1.223	Marco Lateral 3 guías		03
MT-6540	2.052	Marco Umbral 3 guías		03
MT-6516	0.867	Premarco para corrediza de 3 guías corte a 90°		04
MT-6517	0.532	Premarco		04
MT-6553	0.386	Encuentro central para 4 hojas		04
MT-0415	0.200	Tapa junta		04
MT-3202	0.348	Tapa junta curvo		04
MT-6552	1.245	Refuerzo parante central		05
MT-6151	0.732	Hoja Mosquitero Super Reforzado		05
MT-6505	0.316	Tope mosquitero 90°		05
MT-6554	0.316	Perfil guía de mosquitero		05

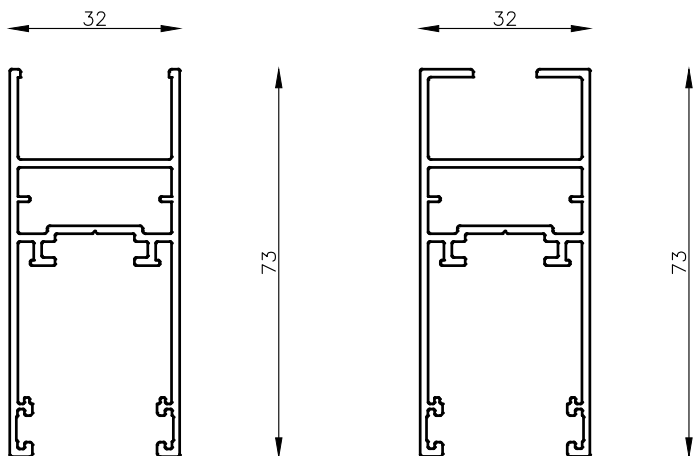

**MT-6548**  
 Hoja perimetral DVH  
 Área: 357 mm<sup>2</sup>  
 Peso: 0.963 Kg/m.-  
 Jx: 6,3978 cm<sup>4</sup>  
 Wx: 3,9986 cm<sup>3</sup>

**MT-6549**  
 Hoja perimetral VS  
 Área: 379 mm<sup>2</sup>  
 Peso: 1.028 Kg/m.-  
 Jx: 6,6546  
 Wx: 4,1596 cm<sup>3</sup>

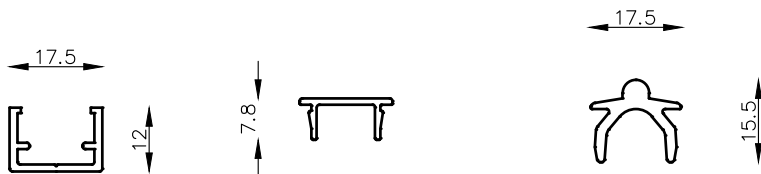

**MT-6544**  
 Marco Lateral  
 Área: 61 mm<sup>2</sup>  
 Peso: 0.165 Kg/m.-

**MT-6545**  
 Tapa parante lateral  
 Área: 34 mm<sup>2</sup>  
 Peso: 0.097 Kg/m.-

**MT-6541**  
 Guía postiza  
 Área: 87 mm<sup>2</sup>  
 Peso: 0.235 Kg/m.-

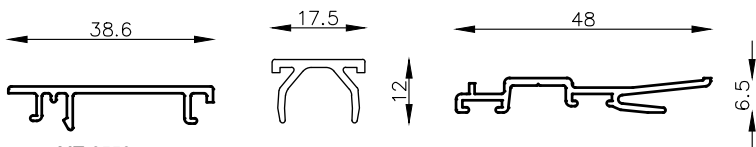

**MT-6550**  
 Tapa de hoja  
 Área: 75 mm<sup>2</sup>  
 Peso: 0.204 Kg/m.-

**MT-6555**  
 Guía para paño fijo  
 Área: 59 mm<sup>2</sup>  
 Peso: 0.159 Kg/m

**MT-6551**  
 Solapa de hoja  
 Área: 75 mm<sup>2</sup>  
 Peso: 0.204 Kg/m.-

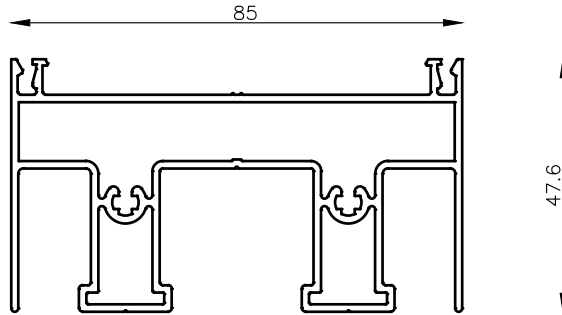

MT-6546  
Marco Dintel  
Área: 611 mm<sup>2</sup>  
Peso: 1.649 Kg/m.-

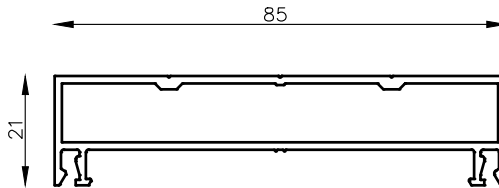

MT-6542  
Marco Lateral  
Área: 320 mm<sup>2</sup>  
Peso: 0.864 Kg/m.-

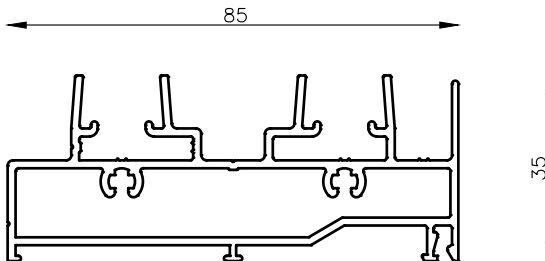

MT-6539  
Marco Umbral  
Área: 517 mm<sup>2</sup>  
Peso: 1.396 Kg/m.-

Esc 1:1

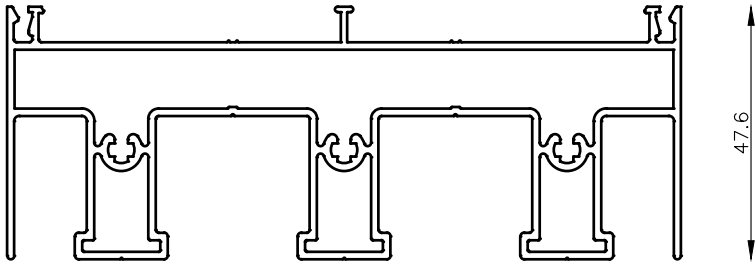

127

MT-6547  
Marco Dintel 3 guías  
Área: 854 mm<sup>2</sup>  
Peso: 2.305 Kg/m.-

127

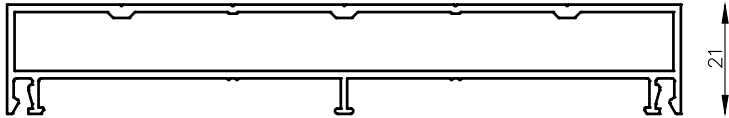

21

MT-6543  
Marco Lateral 3 guías  
Área: 453 mm<sup>2</sup>  
Peso: 1.223 Kg/m.-

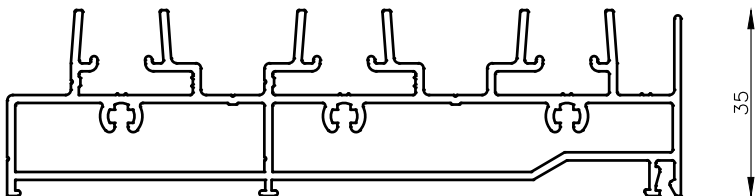

127

MT-6540  
Marco Umbral 3 guías  
Área: 760 mm<sup>2</sup>  
Peso: 2.052 Kg/m.-

35

Esc 1:1

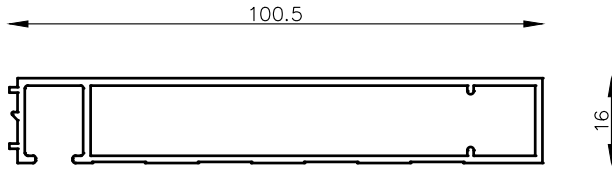

**MT-6516**  
 Premarco 3 Guías  
 Área: 321 mm<sup>2</sup>  
 Peso: 0.867 Kg/m.-

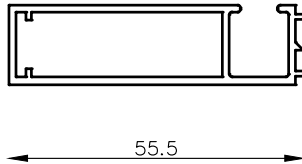

**MT-6517**  
 Premarco  
 Área: 197 mm<sup>2</sup>  
 Peso: 0.532 Kg/m.-

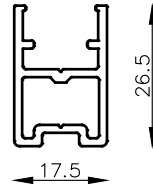

**MT-6553**  
 Encuentro central para 4 hojas  
 Área: 143 mm<sup>2</sup>  
 Peso: 0.386 Kg/m.-

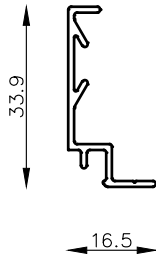

**MT-0415**  
 Tapa junta  
 Peso: 0.200 Kg/m.-

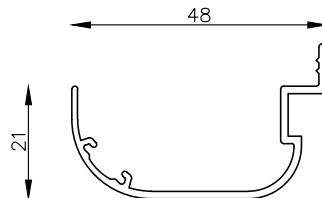

**MT-3202**  
 Tapa junta curvo  
 Peso estimado: 0.348 Kg/m  
 Largo STD: 6200 mm

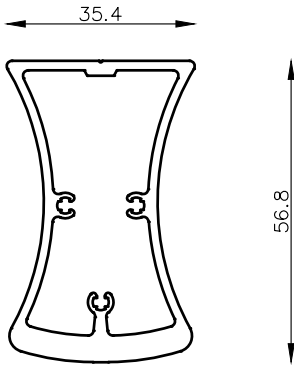

**MT-6552**  
Refuerzo parante central  
Área: 461 mm<sup>2</sup>  
Peso: 1.245 Kg/m.-

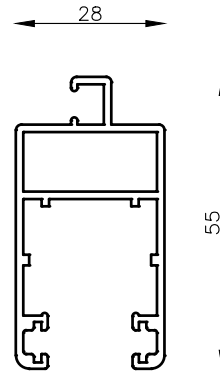

**MT-6151**  
Hoja Mosquitero Super Reforzado  
Área: 271 mm<sup>2</sup>  
Peso: 0.732 Kg/m.-

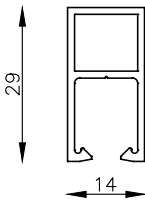

**MT-6505**  
Tope mosquitero 90°  
Peso estimado: 0.316 Kg/m  
Largo STD: 6200 mm

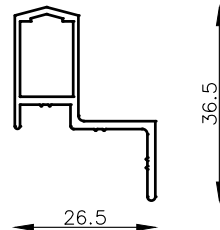

**MT-6554**  
Perfil guía de mosquitero  
Área: 117 mm<sup>2</sup>  
Peso: 0.316 Kg/m.-