

# CATALOGO OFICIAL

**MDT**



**PDP**



PERFILES DEL PILAR

**MDT**



TECNOLOGÍA EN  
ALUMINIO Y VIDRIO







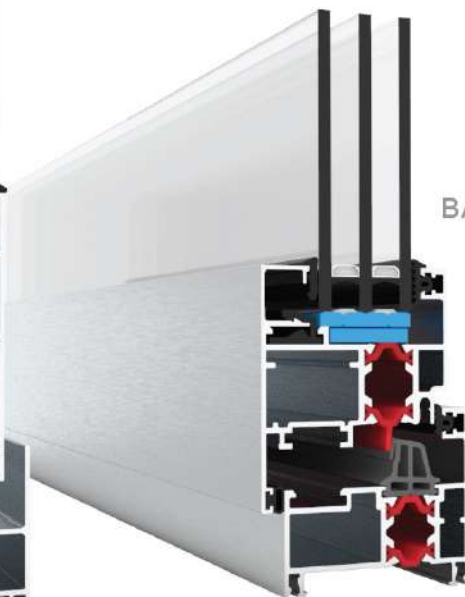











CORREDIZA



























BATIENTE



MASS  
**R**<sub>RPT</sub>  
60  
ENERGY SAVING

CÓDIGO Ensamble	PESO (kg/m) Al + PA25%FV	DESCRIPCIÓN	FORMA	PÁG.
MRPT-001	1.337	Marco para paño fijo		02
MRPT-002	1.304	Marco para ventana batiente		02
MRPT-003	1.223	Marco para ventana desplazable		02
MRPT-004	1.412	Travesaño para paño fijo		02
MRPT-005	2.228	Travesaño para puerta batiente		03
MRPT-006	1.223	Encuentro central para VR Y PR		03
MRPT-007	1.414	Hoja para ventana batiente		02
MRPT-008	1.850	Hoja para puerta batiente		03
MRPT-009	3.302	Zócalo para puerta batiente		03
MRPT-010	1.677	Hoja para ventana desplazable		02
MRPT-011	1.720	Marco corredizo de dos guías		01
MRPT-012	2.403	Marco corredizo de tres guías		01
MRPT-013	1.489	Hoja corrediza DVH hasta 32mm		01
MRPT-014	2.168	Acople reforzado		05
MRPT-015	2.041	Acople a 90°		05
MRPT-016	1.584	Travesaño patagónico		04
MRPT-017	1.319	Marco de hoja oculta		04
MRPT-018	1.617	Travesaño Batiente + PF hoja oculta		04

CÓDIGO	PESO (kg/m)	DESCRIPCIÓN	FORMA	PÁG.
MT-0206	0.184	Tapa junta		06
MT-0217	0.292	Contra vidrio recto interior 29mm		07
MT-0225	0.257	Contra vidrio recto interior 22mm		07
MT-0226	0.210	Contra vidrio recto interior 15mm		07
MT-0230	0.213	Contra vidrio curvo interior 29mm		08
MT-0231	0.159	Contra vidrio curvo interior 15mm		08
MT-0232	0.181	Contra vidrio curvo interior 22mm		08
MT-0233	0.135	Contra vidrio curvo interior 8mm		08
MT-0238	0.183	Contra vidrio recto interior 8mm		9 - 11
MT-0303	0.108	Contra vidrio para hoja oculta		9 - 11
MT-0305	0.257	Suplemento para contra vidrio de PF en hoja oculta		07
MT-0415	0.200	Tapa junta recto		07
MT-0538	0.937	Hoja oculta para DVH 24mm		07
MT-0542	0.597	Hoja mosquitero		06
MT-0543	0.154	Solapa mosquitero		06
MT-3202	0.348	Tapa junta curvo		08
MT-6090	0.159	Pletina		05
MT-6323	0.462	Guía mosquitero		05
MT-6324	1.137	Refuerzo de parante central		05
MT-6325	0.437	Umbral para puerta batiente		05
MT-6326	0.167	Solapa de hoja para puerta batiente		05
MT-6329	0.170	Tapa junta		06
MT-6330	0.122	Acople a 180°		06
MT-6332	0.181	Contra vidrio recto interior 15 mm patagónico		9 - 11
MT-6336	0.575	Solapa central mas aislante		05

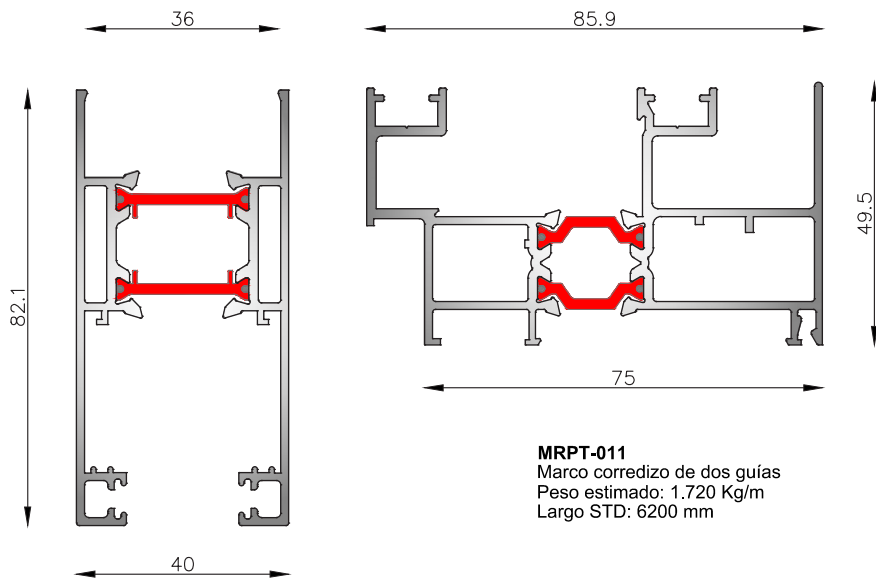

**MRPT-013**  
 Hoja corrediza DVH hasta 32mm  
 Peso estimado: 1.489 Kg/m  
 Largo STD: 6200 mm

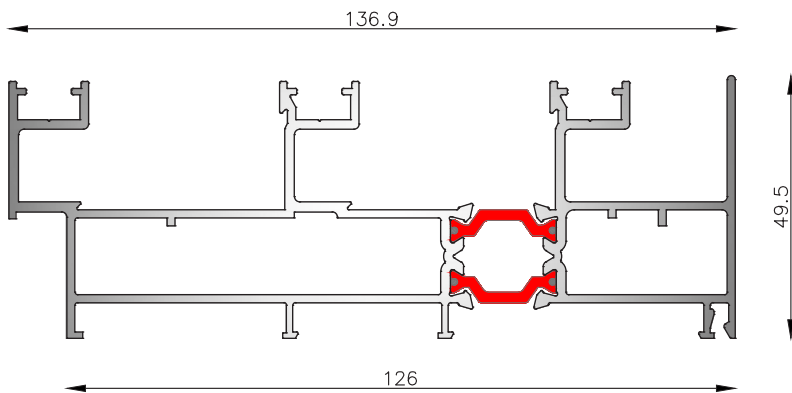

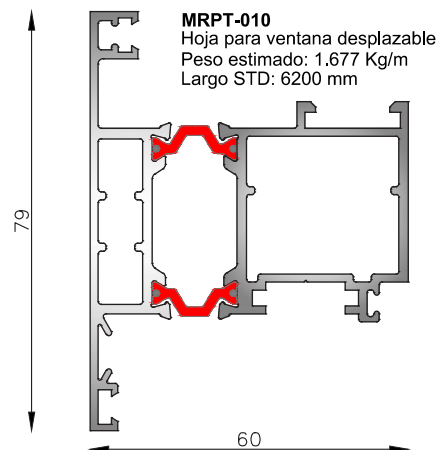
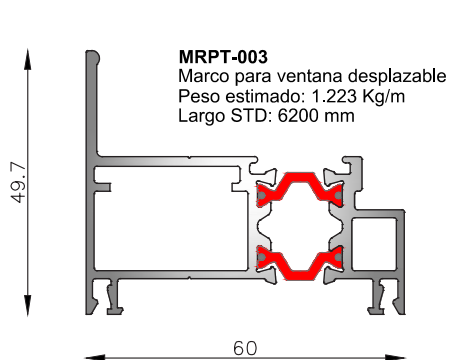
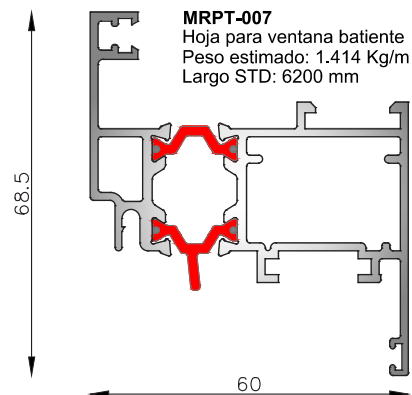
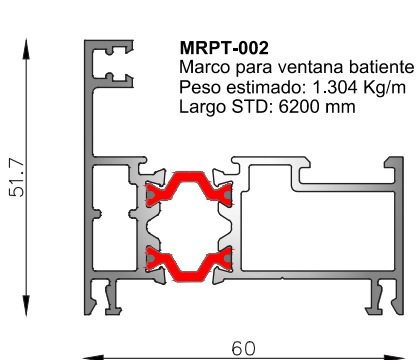
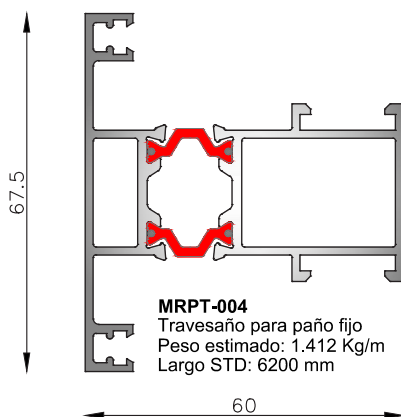
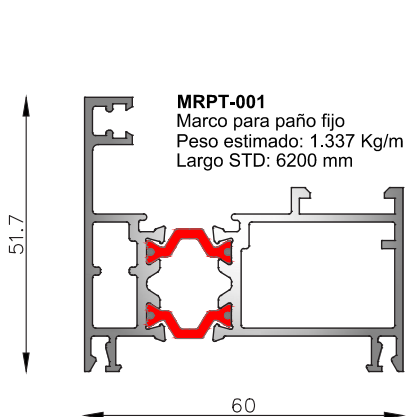

Esc 1:1

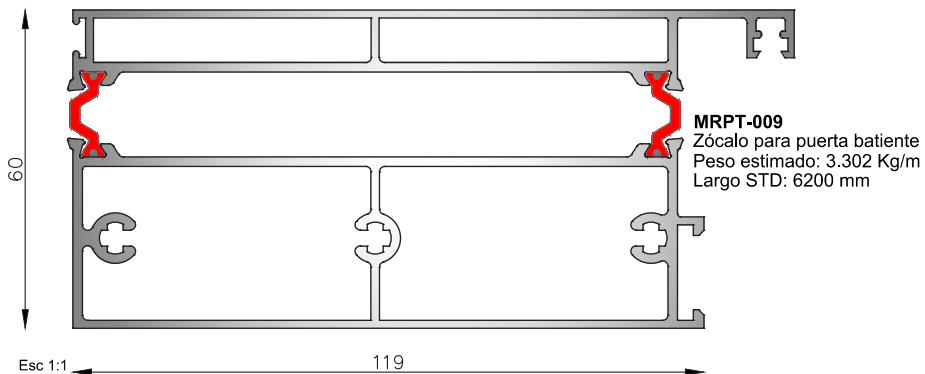
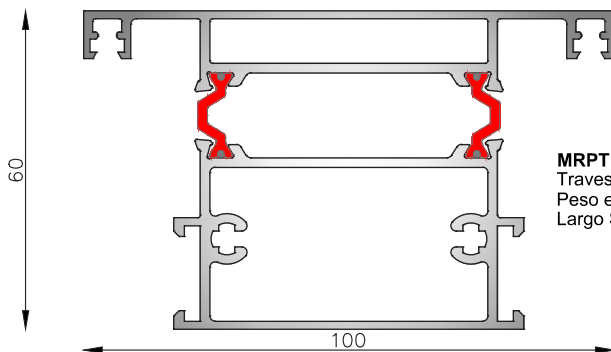
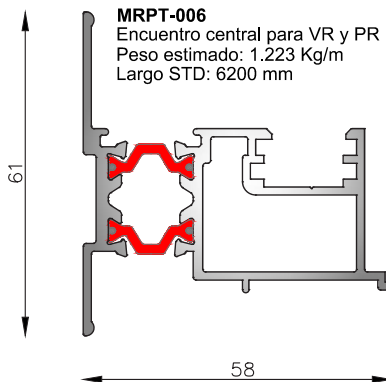
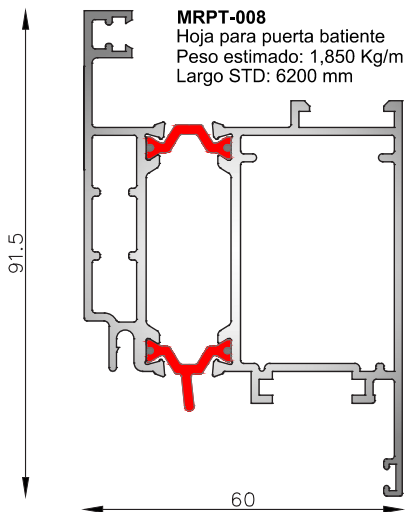

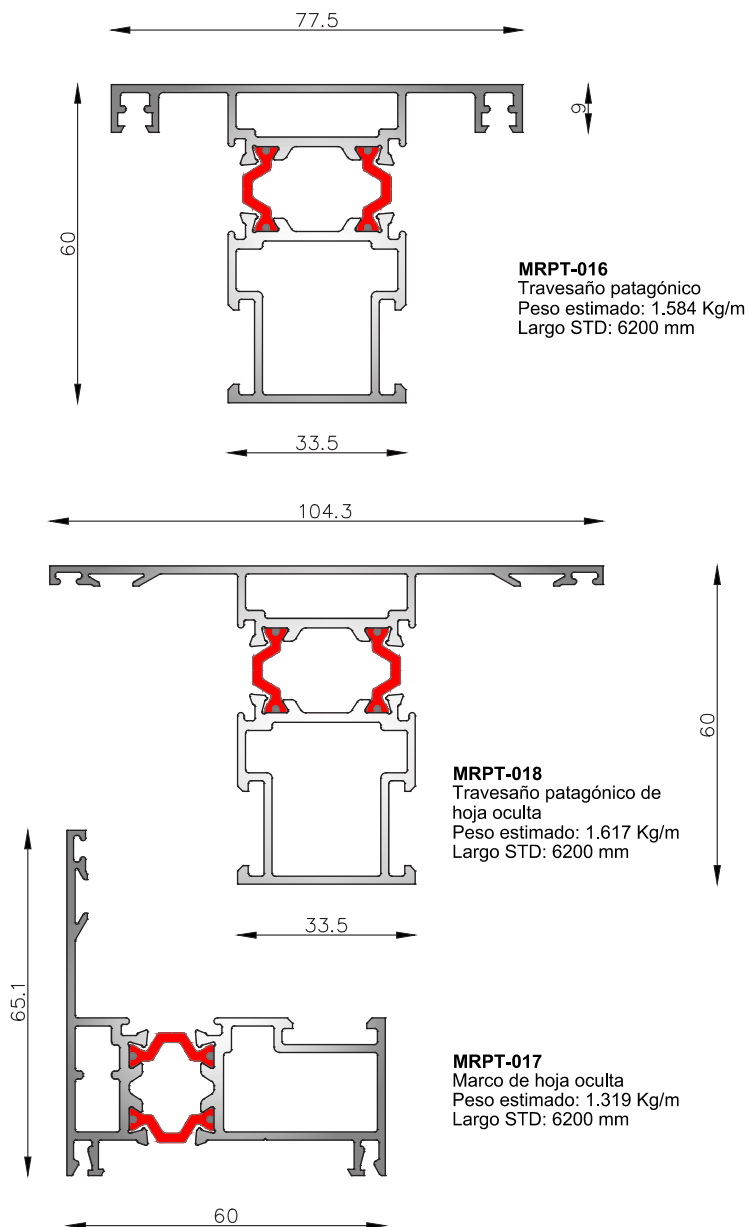



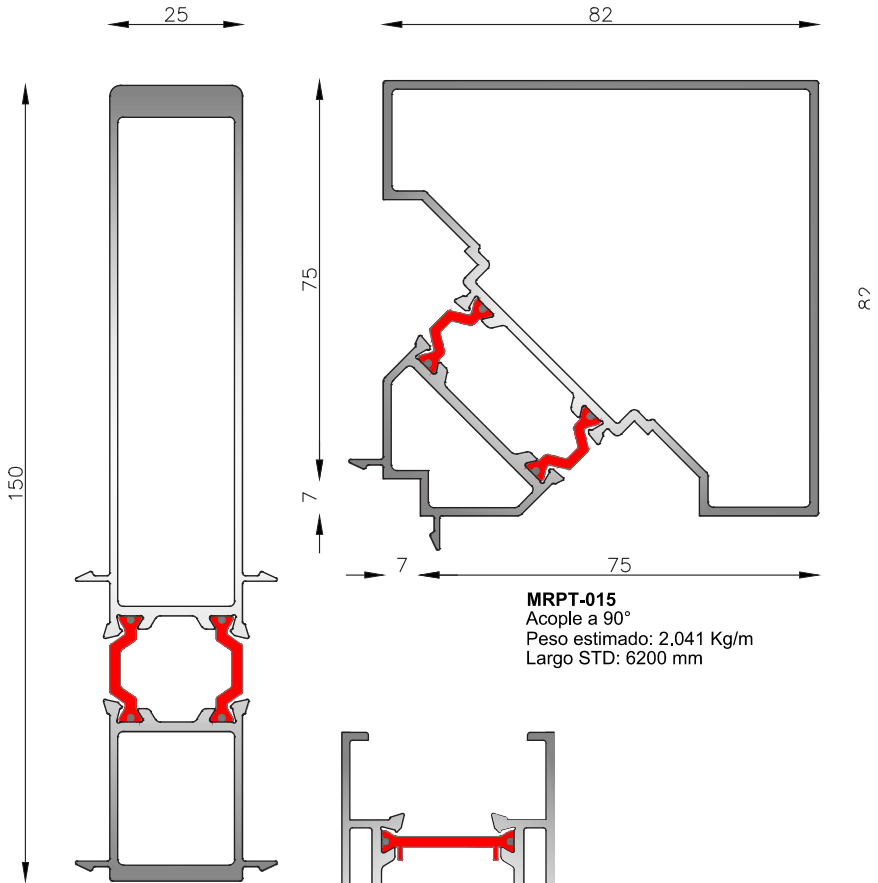

**MRPT-014**  
 Acople Reforzado  
 Peso estimado: 2.168 Kg/m  
 Largo STD: 6200 mm

**MRPT-015**  
 Acople a 90°  
 Peso estimado: 2.041 Kg/m  
 Largo STD: 6200 mm

**MRPT-019**  
 Hoja Corrediza  
 Peso estimado: 1.543 Kg/m (Al+Pc)  
 Largo STD: 6200 mm

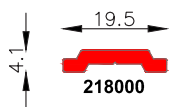

Pletina para falleba en varilla de poliamida (Estándar)

**Código 218000**

Se aplica en hojas batientes con cámara europea

Largo de tira 6200 mm

(No apta para herrajes Roto Frank)

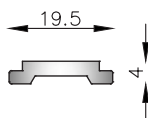

**MT-6090**

Pletina Estándar en Aluminio

Peso estimado: 0.159 Kg/m

Largo STD: 6030 mm

(No apta para herrajes Roto Frank)

(Ver opción en PA superior)

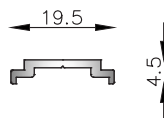

**MT-6518**

Pletina Roto Frank en Aluminio

Peso estimado: 0.103 Kg/m

Largo STD: 6030 mm

(Apta para todos los herrajes Estándar)

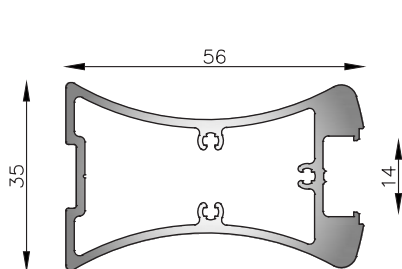

**MT-6324**

Refuerzo de parante central

Peso estimado: 1,137 Kg/m

Largo STD: 6200 mm

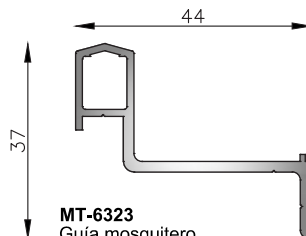

**MT-6323**

Guía mosquitero

Peso estimado: 0,462 Kg/m

Largo STD: 6200 mm

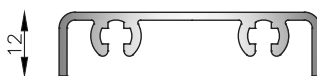

**MT-6325**

Umbral para PR

Peso estimado: 0,437 Kg/m

Largo STD: 6200 mm

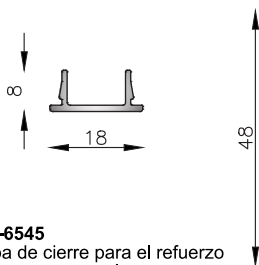

**MT-6545**

Tapa de cierre para el refuerzo

de parante central

Peso estimado: 0,097 Kg/m

Largo STD: 6200 mm

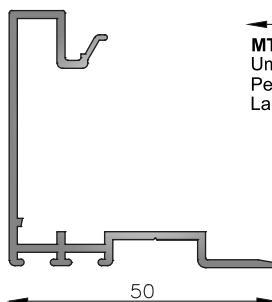

**MT-6336**

Solapa central

Peso estimado: 0,575 Kg/m

Largo STD: 6200 mm

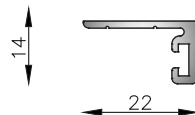

**MT-6326**

Solapa de hoja PR

Peso estimado: 0,167 Kg/m

Largo STD: 6200 mm

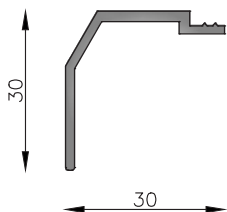

**MT-6337**  
Gotero para corrediza  
Peso estimado: 0,270 Kg/m  
Largo STD: 6200 mm

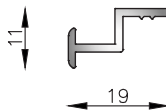

**MT-6330**  
Acople a 180°  
Peso estimado: 0,122 Kg/m  
Largo STD: 6200 mm

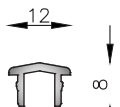

**MT-6513**  
Guía de marco 90°  
Peso estimado: 0,085 Kg/m  
Largo STD: 6200 mm

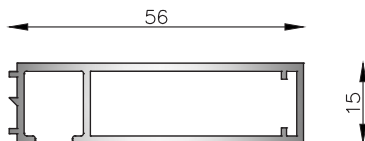

**MT-6517**  
Premarco  
Peso estimado: 0,532 Kg/m  
Largo STD: 6200 mm

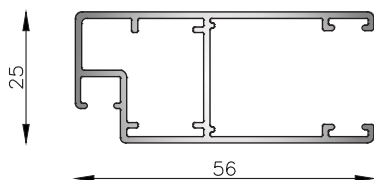

**MT-0542**  
Hoja de mosquitero  
Peso estimado: 0,597 Kg/m  
Largo STD: 6200 mm

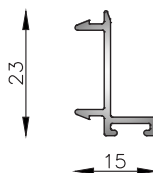

**MT-0543**  
Solapa mosquitero  
Peso estimado: 0,154 Kg/m  
Largo STD: 6200 mm

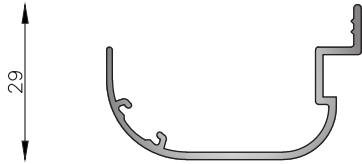

**MT-3202**

Tapa junta curvo  
 Peso estimado: 0.348 Kg/m  
 Largo STD: 6150 mm

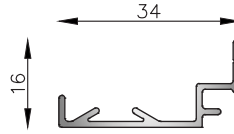

**MT-0415**

Tapa junta recto  
 Peso estimado: 0.200 Kg/m  
 Largo STD: 6150 mm

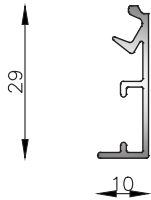

**MT-6329**

Tapa Junta para clip  
 Peso estimado: 0.170 Kg/m  
 Largo STD: 6200 mm

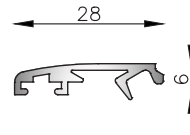

**MT-0206**

Tapa junta para clip  
 Peso estimado: 0.184 Kg/m  
 Largo STD: 6150 mm

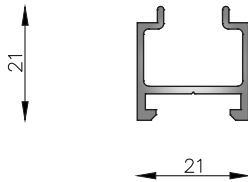

**MT-0305**

Suplemento para contravidrio de PF en hoja oculta  
 Peso estimado: 0.257 Kg/m  
 Largo STD: 6200 mm

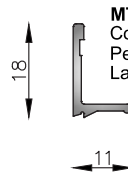

**MT-0303**

Contravidrio para hoja oculta  
 Peso estimado: 0.108 Kg/m  
 Largo STD: 6200 mm

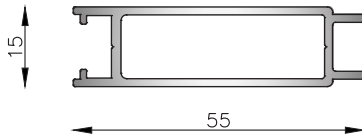

**MT-6338**

Encuentro central para 4 hojas  
 Peso estimado: 0.564 Kg/m  
 Largo STD: 6200 mm

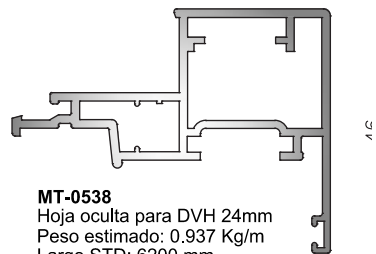

**MT-0538**

Hoja oculta para DVH 24mm  
 Peso estimado: 0.937 Kg/m  
 Largo STD: 6200 mm

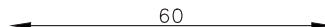

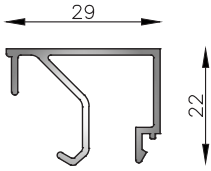

**MT-0217**  
 Contravidrio recto interior 29mm  
 Peso estimado: 0.292 Kg/m  
 Largo STD: 6030 mm

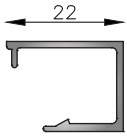

**MT-6569**  
 Mass R60 Contravidrio 17 mm  
 Peso estimado: 0.194 Kg/m  
 Largo STD: 6200 mm

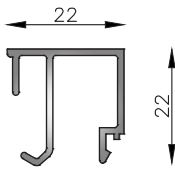

**MT-0225**  
 Contravidrio recto interior 22mm  
 Peso estimado: 0.257 Kg/m  
 Largo STD: 6030 mm

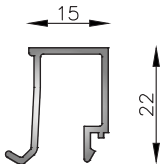

**MT-0226**  
 Contravidrio recto interior 15mm  
 Peso estimado: 0.210 Kg/m  
 Largo STD: 6030 mm

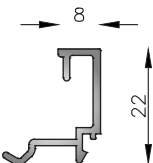

**MT-0238**  
 Contravidrio recto interior 8mm  
 Peso estimado: 0.183 Kg/m  
 Largo STD: 6030 mm

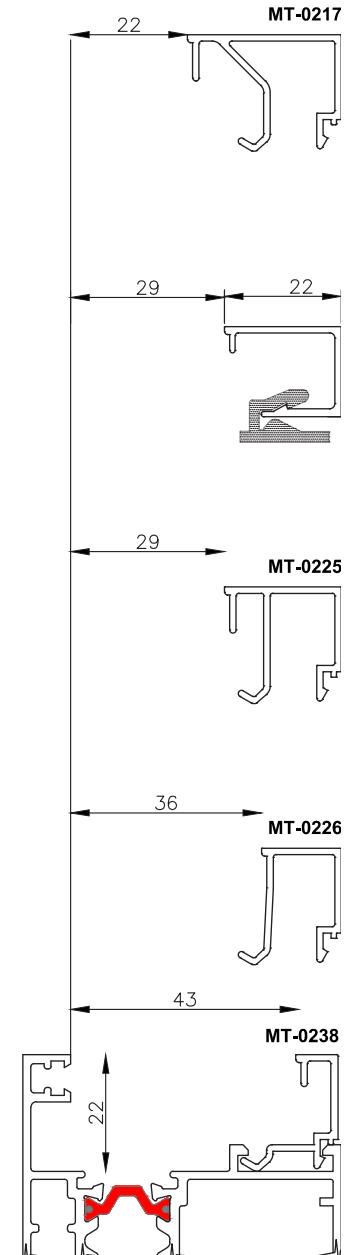

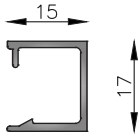

**MT-6535**  
 Contravidrio recto interior 15mm  
 Peso estimado: 0.166 Kg/m  
 Largo STD: 6030 mm

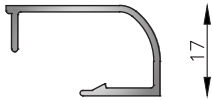

**MT-0230**  
 Contravidrio curvo interior 29mm  
 Peso estimado: 0.213 Kg/m  
 Largo STD: 6030 mm

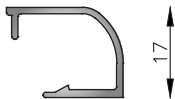

**MT-0232**  
 Contravidrio curvo interior 22mm  
 Peso estimado: 0.181 Kg/m  
 Largo STD: 6030 mm



**MT-0231**  
 Contravidrio curvo interior 15mm  
 Peso estimado: 0.159 Kg/m  
 Largo STD: 6030 mm

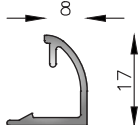

**MT-0233**  
 Contravidrio curvo interior 8mm  
 Peso estimado: 0.135 Kg/m  
 Largo STD: 6030 mm

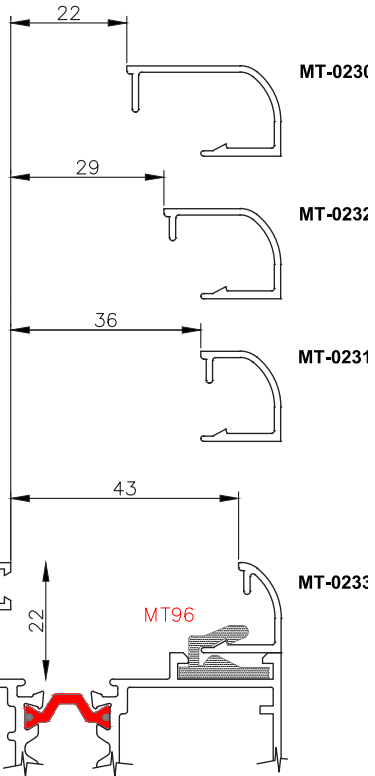
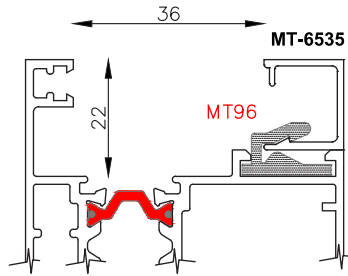

**Atención:** Colocar un clip de contravidrio MT96 a 40mm de cada esquina y el resto a una distancia máxima de 200 entre cada uno. En caso de necesitar retirar el contravidrio cambiar los MT96, debido a que pierde su capacidad sujeción. Todos los valores son orientativos y están sujetos a las propias tablas de los fabricantes de barras.

### Contravidrios para Paño Fijo Patagónico

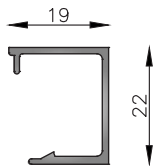

**MT-6568**  
 Contravidrio recto interior 19 mm  
 "Patagónico"  
 Peso estimado: 0.194 Kg/m  
 Largo STD: 6200 mm

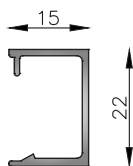

**MT-6332**  
 Contravidrio recto interior 15 mm  
 "Patagónico"  
 Peso estimado: 0.181 Kg/m  
 Largo STD: 6200 mm

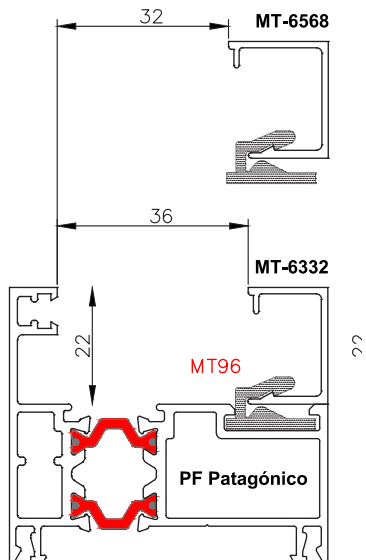

### Contravidrios para Batientes

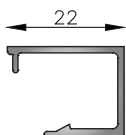

**MT-6569**  
 Contravidrio recto interior 22 mm  
 Peso estimado: 0.189 Kg/m  
 Largo STD: 6200 mm



**MT-6535**  
 Contravidrio recto interior de 15mm  
 Peso estimado: 0.166 Kg/m  
 Largo STD: 6030 mm

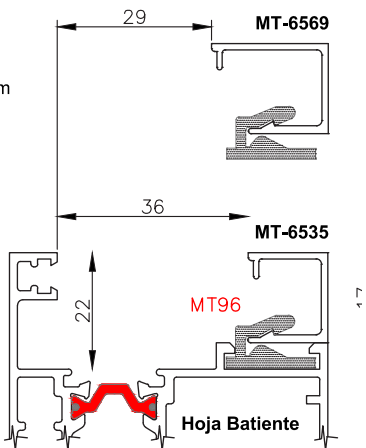

**Atención:** Colocar un clip de contravidrio MT96 a 40mm de cada esquina y el resto a una distancia máxima de 200 entre cada uno. En caso de necesitar retirar el contravidrio cambiar los MT96, debido a que pierde su capacidad sujeción. Todos los valores son orientativos y están sujetos a las propias tablas de los fabricantes de herrajes garanticen su funcionalidad y durabilidad.

Esc 1:1